

Data Sheet



Article number: 03556050

Description: Fluro hydraulic rod end FS 50N

Measures

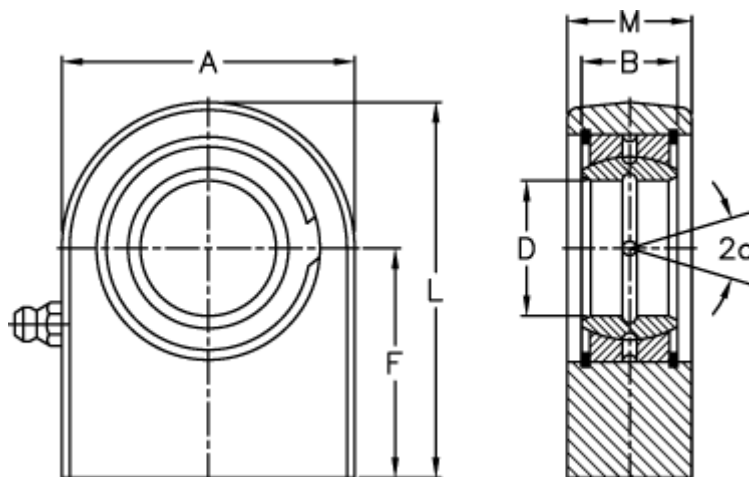

A	= 123	Static load C0 (kN) = 440
a (degrees)	= 6	Weight = 4450
B	= 35	
D	= 50	
Dynamic load C (kN)	= 156	
F	= 88	
L	= 149.5	
M	= 40	